

DESCRIPTION

The DIP series is a very compact design having a low profile package and a high profile package. This series is compatible with all DIP relays.

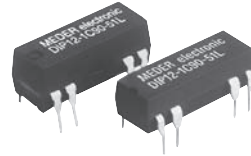

FEATURES

- High resistance option available
- SMD version available
- Diode option available
- Mercury wetted switch option available

CHARACTERISTICS

- Low profile package
- Standard pin configurations
- IC-pin compatible
- 4.25 kVDC breakdown voltage for pin out 13
- UL approval

DIMENSIONS

All dimensions in mm [inches]

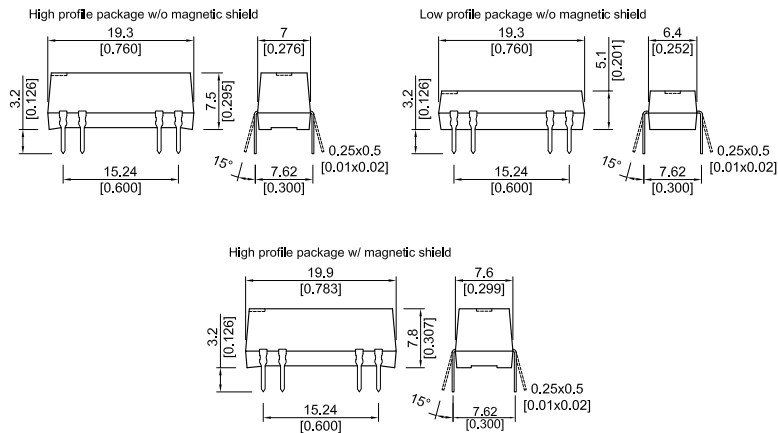

Molded DIP Reed Relays

ORDER INFORMATION

RELAY SERIES	NOMINAL VOLTAGE	CONTACT FORM	SWITCH MODEL	PIN OUT	OPTION () VERSION WITH MAGNETIC SHIELD
DIP	XX -	XX	XX -	XX	X
OPTIONS	05, 12, 15, 24	1A	72, 75	11, 13*	L (M), D (Q), E (R), F (S)
		1B		19	
		2A		21	
	05, 12	1C	90	51	

* Selects 4.25 kVDC (3.0kVRMS) breakdown voltage contact to coil.

Part Number Example

DIP12 - 1A72 - 13L

12 is the nominal voltage

1A is the contact form

72 is the switch model

13 is the pin out

L is the option

PIN OUT

View from top of component
2.54mm [0.10"] pitch grid

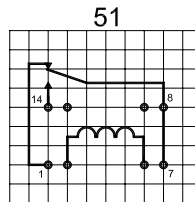
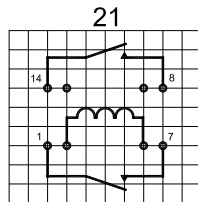
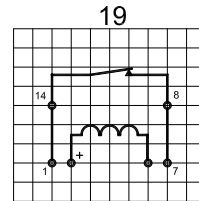
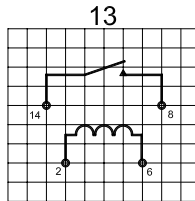
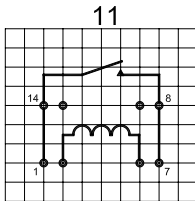

OPTIONS

() Versions with magnetic shield

View from top of component
2.54mm [0.10"] pitch grid

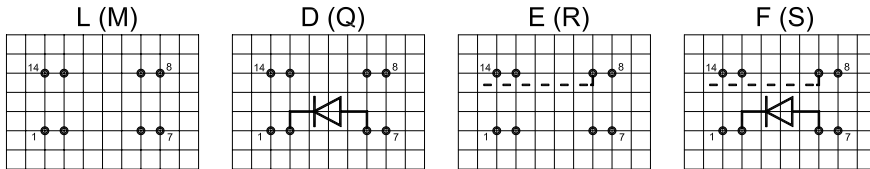

OPTIONS DEPENDENCE ON CASE SIZES

CONTACT FORM	PACKAGE SIZE	PIN OUT	OPTIONS								
			L	D	E	F	M	Q	R	S	
1A	Low Profile	11	X		X						
		13	X								
	High Profile	11		X		X	X	X		X	
		13		X			X	X			
1B	High Profile	19	X	X			X	X			
2A	High Profile	21	X	X	X	X	X	X	X	X	
1C	Low Profile	51	X								
	High Profile			X	X	X	X	X	X	X	

- L = No option
- D = With Diode between pin 2 and 6 (Pin 2 is positive)
- E = Internal shield on pin 9
- F = With Diode between pin 2 and 6 (Pin 2 is positive) and Internal shield on pin 9
- M = External magnetic shield
- Q = External magnetic shield and diode between pin 2 and 6 (Pin 2 is positive)
- R = External magnetic shield and internal shield on pin 9
- S = External magnetic shield and with diode between pin 2 and 6 (Pin 2 is positive) and internal shield on pin 9

Molded DIP Reed Relays

RELAY DATA

All data at 20 °C	Switch Model -> Contact Form ->	Contact 72 Form A / B			Contact 75 Form A / B			Contact 90 Form C			
Contact Ratings	Conditions	Min.	Typ.	Max.	Min.	Typ.	Max.	Min.	Typ.	Max.	Units
Switching Power	Any DC combination of V & A not to exceed their individual max.'s			20			10			3	W
Switching Voltage	DC or peak AC			200			1000			175	V
Switching Current	DC or peak AC			1.0			0.5			0.25	A
Carry Current	DC or peak AC			1.25			1.0			1.2	A
Static Contact Resistance	w/ 0.5V & 50mA			150			200			150	mΩ
Dynamic Contact Resistance	Measured w/ 0.5V & 50mA 1.5 ms after closure			200			200			250	mΩ
Insulation Resistance (100 Volts applied)	Across contacts Contact to coil	10 ¹² 10 ¹²			10 ¹⁰ 10 ¹²			10 ⁹ 10 ¹²			Ω
Breakdown Voltage	Across contacts Contact to coil	320 1500*			1000** 1500*			200 1500			VDC
Operate Time, incl. Bounce	Measured w/ 100% overdrive			0.5			0.5			0.7	ms
Reset Time	Measured w/ no coil suppression			0.1			0.1			1.5	ms
Capacitance	Across contacts Contact to coil		0.2 2.0			0.4 2.0			1.0 3.0		pF
Life Expectancies											
Switching 5 Volts@ 10mA	DC only & <10 pF stray cap.		1000			500			100		10 ⁶ Cycles
For other load requirements please see our life test section located on page 151.											
Environmental Data											
Shock Resistance	1/2 sine wave duration 11ms			50			50			50	g
Vibration Resistance	From 10 - 2000 Hz			20			20			20	g
Ambient Temperature	10 °C/ minute max. allowable	-20		70	-20		70	-20		70	°C
Storage Temperature	10 °C/ minute max. allowable	-35		95	-35		95	-35		95	°C
Soldering Temperature	5 sec. dwell			260			260			260	°C

* Selects pin out 13 and 4.25 kVDC (3.0 kVRMS) breakdown voltage contact to coil. ** For higher voltage requirements please consult factory.

COIL DATA

CONTACT FORM	SWITCH MODEL	COIL VOLTAGE		COIL RESISTANCE			PULL-IN VOLTAGE		DROP-OUT VOLTAGE		NOMINAL COIL POWER		
		VDC		Ω			VDC		VDC		mW		
All data at 20 °C *													
		Nom.	Max.	Min.	Typ.	Max.	Min.	Max.	Min.	Max.	Typ.		
1A	72 75	5	7.5	450 (180)	500 (200)	550 (220)	0.85	3.5	0.75	3.4	50		
		12	16	900	1000	1100	1.9	8.4	1.8	8.3	145		
		15	20	1800	2000	2200	2.3	10.5	2.2	10.4	115		
		24	30	1800	2000	2200	3.7	16.8	3.6	16.7	290		
1B**		72 75	5	7.5	450 (180)	500 (200)	550 (220)	0.85	3.5	0.75	3.4	50	
			12	16	900	1000	1100	1.9	8.4	1.8	8.3	145	
			15	20	1800	2000	2200	2.3	10.5	2.2	10.4	115	
			24	30	1800	2000	2200	3.7	16.8	3.6	16.7	290	
2A			72 75	5	7.5	180 (126)	200 (140)	220 (154)	0.85	3.5	0.75	3.4	125
				12	16	450	500	550	1.9	8.4	1.8	8.3	290
				15	20	1800	2000	2200	2.3	10.5	2.2	10.4	115
				24	30	1800	2000	2200	3.7	16.8	3.6	16.7	290
1C	90			5	7.5	180	200	220	0.85	3.5	0.75	3.4	125
				12	16	450	500	550	1.9	8.4	1.8	8.3	290
				15	20	1800	2000	2200	2.3	10.5	2.2	10.4	115
				24	30	1800	2000	2200	3.7	16.8	3.6	16.7	290

() versions with magnetic shield.
 * The pull-in / drop-out voltage and coil resistance will change at the rate of 0.4% per °C.
 ** Reclosure of the Form B may occur if the max. coil voltage is exceeded. Coil polarity on Form B must be observed. Pin two is positive.